

Adjustable Floor Drain

Phễu Thu Nước Sàn Điều chỉnh



Kiểu Mặt Tròn D1..R Round Top Model

Option: Slots on Grate
Tùy chọn: Dạng Rãnh Nắp

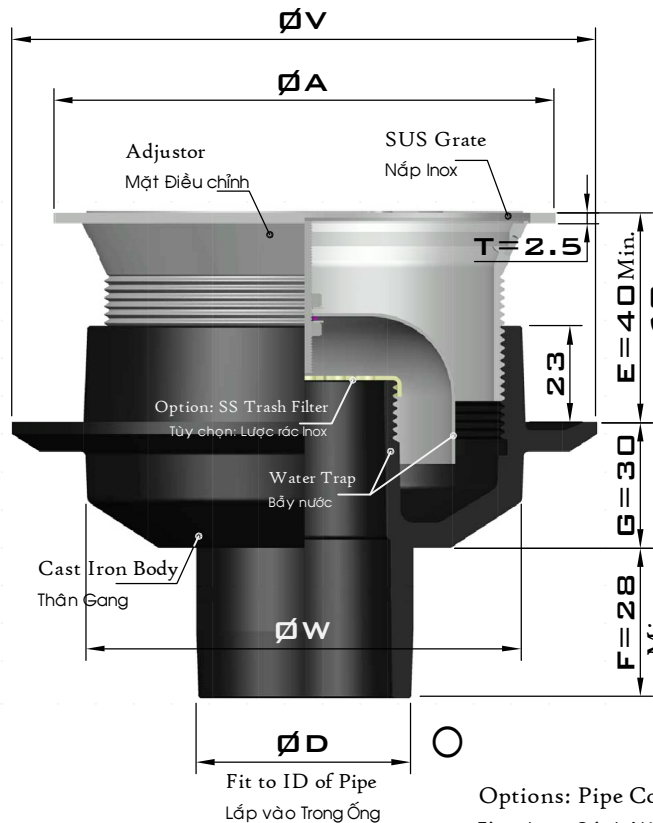

Key Features

- Materials: Cast Iron+SUS 304
- Water Out Fast
- Prevent foul smell
- Hair/Trash Blocking
- Good waterproof
- Easy to adjust the height

Đặc điểm

- Vật liệu: Gang + Inox 304
- Thoát nước nhanh
- Ngăn mùi
- Ngăn Rác, Cản Tóc
- Chống thấm tốt
- Điều chỉnh chiều cao dễ dàng

Curved Slots
Rãnh Cong 1

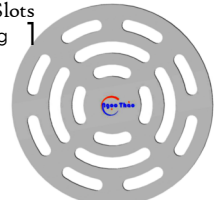

Straight Slots
Rãnh Thẳng 2

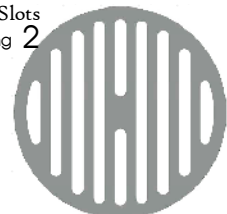

Daisy
Hoa Cúc 6

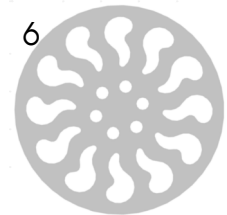

Asterisk
Hoa Thị X

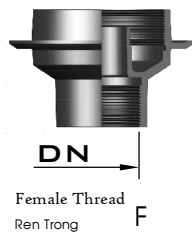
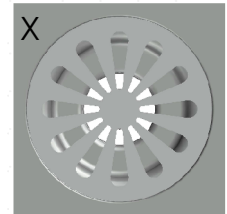

Female Thread
Ren Trong F

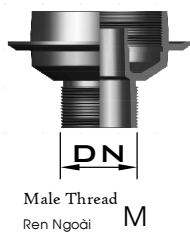

Male Thread
Ren Ngoài M

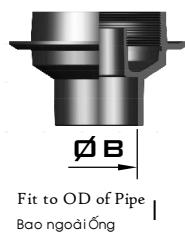

Fit to OD of Pipe
Bao ngoài Ống I

Options: Pipe Connection
Tùy chọn: Cách Nối Ống

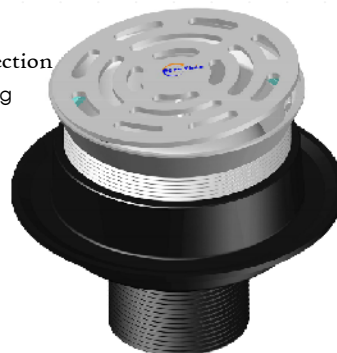

Pipe Size	ØA	ØB	ØW	ØD	ØV	Free Area	Code
Kích thước Ống	(mm)	(mm)	(mm)	(mm)	(mm)	Diện tích Rãnh thoát (mm ²)	Mã số
(in) (OD)							
DN40 1 1/2 49	110	50	110	42	140	2,700	D1049 O 110 R?12C
DN50 2 60	110	61	110	52	140	2,700	D1060 O 110 R112C
DN65 2 1/2 75	110	76	110	67	140	2,700	D1075 O 110 R112C
DN80 3 90	110	90	110	81	140	2,700	D1090 ? 110 R112C
DN80 3 90	155	90	155	81	185	6,380	D1090 O 155 R112C
DN100 4 114	155	115	155	102	185	6,380	D1114 O 155 R112C
DN125 5 140	216	141	210	125	240	11,150	D1140 O 216 R112C
DN150 6 168	216	169	210	152	240	11,150	D1168 O 216 R112C
DN200 8 200	216	200	210	180	240	11,150	D1200 O 216 R1?2C
DN200 8 220	216	220	210	200	240	11,150	D1220 O 216 R112C

1 With water trap, no trash filter
Có bẫy nước, không lược rác

A With water trap & trash filter
Có bẫy nước, có lược rác

Connecting Method
Cách Lắp vào Ống

F/M/O/I

Curved/Straight/
Daisy/Asterisk Slots
Rãnh Cong/Thẳng
/Hoa Cúc/Hoa Thị

1/2/6/X